



DELPHYS Xtend GP

Hot-scalable UPS system

Green Power 2.0 range up to 1.2 MW



Scalability when you need it, while maintaining business continuity

Socomec, a market leader in the development and manufacture of large integrated critical power systems presents the latest addition to its range of energy efficient Green Power 2.0 scalable UPS solutions – the DELPHYS Xtend GP. It combines all the benefits of the Green Power 2.0 technology and the flexibility of a modular system.



SITE 747 A



SITE 749 A

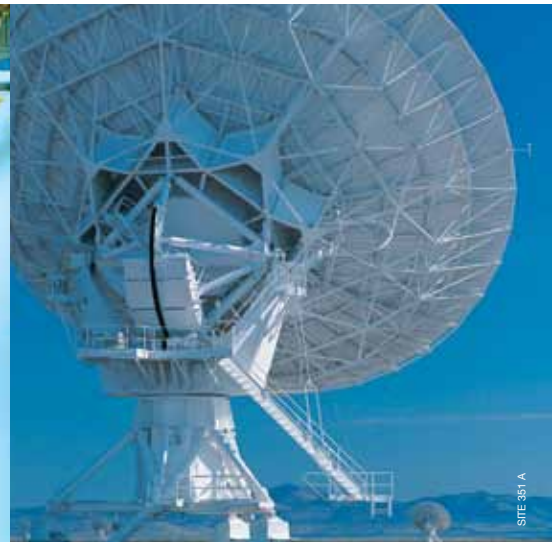

SITE 351 A

Ensuring zero-outage business continuity

Maintaining the uptime of mission critical applications is a major concern for IT or data centre managers.

Availability, reliability & quality as well as quick and risk-free maintainability of the power supply system are key factors in achieving this target.

Aligning capacity to business demand

Changes in IT technology are accelerating, putting pressure on the power infrastructure to keep pace. Providing **scalability** is essential to match short-term capacity and long-term growth requirements along with a cost-effective and fast deployment.

Optimising costs over the full life cycle

Several challenges have to be met to **optimise the cost** of the power infrastructure, from design through to installation and operation. Optimising costs while meeting changes in performance demand and ensuring lifecycle extensions are key issues in data centres.

Benefit from the expertise of the leading player in critical power infrastructure

Socomec is a multi-technology specialist in power, electronics and energy performance systems with many years of experience in providing high availability power solutions and more than 20 years of experience in providing modular solutions.



Socomec's commitment to continuous innovation provides data centre customers with solutions and services that meet the increasing technological complexity and evolving power requirements of cloud computing facilities.



Socomec for sustainability

The entire Green Power 2.0 UPS range is designed to operate in compliance with the EU Code of Conduct governing data centres for reducing energy consumption and associated carbon emissions. A fully accredited PEP Product Environmental Passport is available for this product.



DELPHYS Xtend GP

Easy adaptation to your evolving requirements,
without impacting the surrounding electrical infrastructure

DELPHYS Xtend GP is a real scalable UPS system designed to provide power scalability that can be built up with power blocks to extend the system according to the maximum power requirement.

DELPHYS Xtend GP is the innovative ideal solution for protecting:

- large data centres,
- telecommunications,
- healthcare sector,
- service sector,
- infrastructure,
- processes,
- industrial applications.



Optimized capital employed



Uptime guaranteed



Real hot-scalable solution



Total adaptability



Optimum availability

Hot-scalable system up to 1200 kW



GREEN 130 B



Designed, developed and produced by Socomec, a European specialist manufacturer with more than 20 years of experience in supplying modular solutions.

An innovative way to provide scalability

DELPHYS Xtend GP power scalability is provided by Xmodule power blocks docked onto prewired Xbay docks. The installation and the positioning are easy with secured operation both for operators and the application. During system extensions or maintenance, the load is fully protected in online double conversion mode.



AC CABINET

System input and output.

- System input and output switches, rated for the final power.
- Connections for power and control cables.
- Maintenance manual bypass switch.
- Centralised static bypass, if required.

DC CABINET

Prewired coupling for energy storage.

- Energy storage power and control cable connections.
- Connection of up to 6 batteries with dedicated coupling switches.

Xbay

Easy power block docking.

- Each Xbay dock is prewired to AC and DC cabinets.
- Ready for Xmodule power and control cables connection.
- Includes individual switches for Xmodule AC coupling.
- Hot-plug parallel bus connection.
- The number of Xbay docks depends on the final power required (up to 6).

Xmodule

Hot-scalable 200 kVA/kW power block.

- Power block ensuring load protection and battery management.
- Up to 6 Xmodule power blocks per system.
- Easy positioning.
- Dedicated switches for easy power block servicing.
- Secured installation both for operators and the application.



Real hot-scalable solution

- **Quick and safe scalability** to meet evolving demands for energy performance.
- **Reliable power** that can be increased when needed to rapidly meet changing capacity demands.
- **Easy adaptation to site evolutions and constraints** thanks to movable blocks.
- **Prewired system** for additional Xmodule connection and coupling within the system.
- **Standard tools** required to place and connect the power block.
- **Online double conversion mode** for load protection during system extensions or maintenance.



Xmodule



Designed to save costs

Energy efficiency up to 1200 kW
Based on DELPHYS GP 200 kW, the system has all the advantages of the Green Power 2.0:

- minimised energy consumption and cooling costs in VFI mode,
- unitary power factor provides the best €/kW ratio,
- performance attested by Bureau Veritas.



Prewired Xbay



Safe power scalability

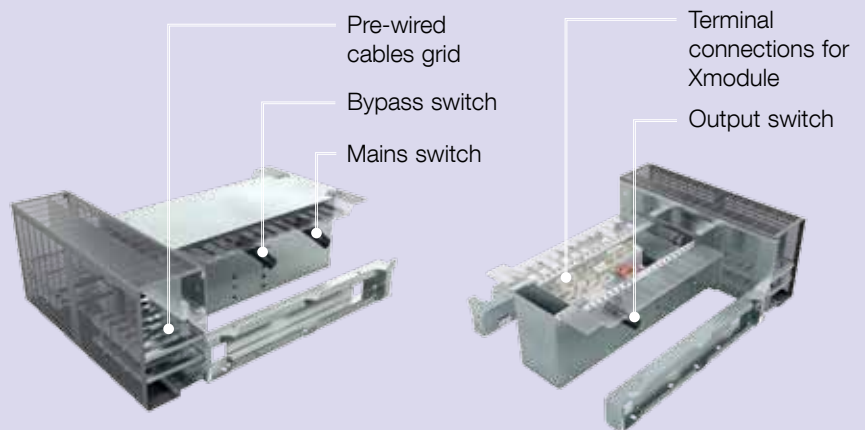

Optimized capital employed

Any environmentally responsible company is naturally concerned about life cycle costs and carbon footprint reduction in its installation. Energy costs and floor space are expensive and will increase over the years. DELPHYS Xtend GP ensures the continuity of your business applications allowing you to optimise the initial investment, the operating and maintenance capital expenditure and to adopt a sustainable development approach.

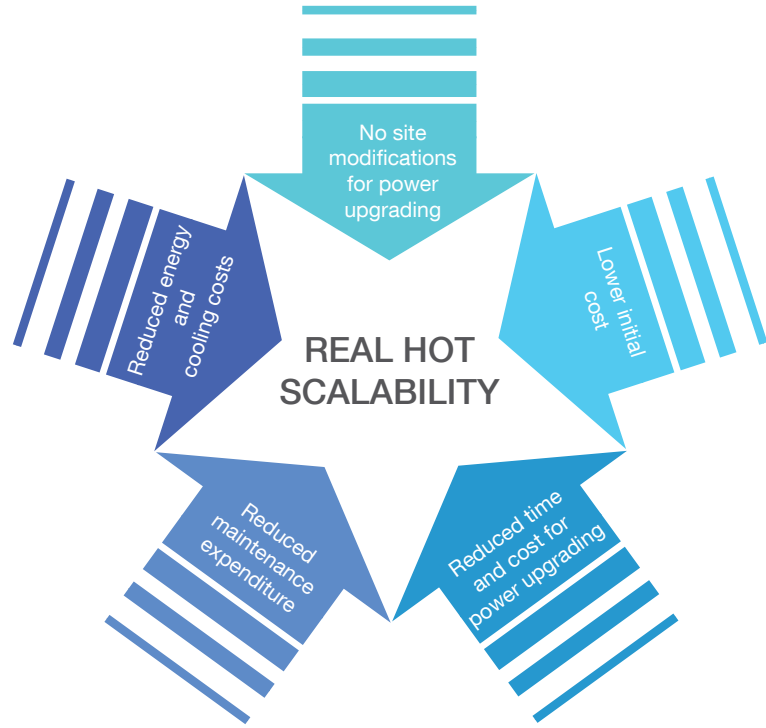

GREEN 145 A GB



Innovative battery discharge test

DELPHYS Xtend GP allows a periodical **complete and safe battery discharge test without using a resistive load** for the back-up time or availability check. **Battery Capacity Re-injection** allows significant **cost savings** and **reduces the TCO**:

- no need to rent or buy load banks,
- **simplified infrastructure**, as there are not any dedicated test bus bars,
- **no wasted energy** because it is re-used to supply other UPS or applications,
- less time needed to perform the test as it is easy to programme.

The test is performed at a constant rate of power (full power or partial load). Each individual Xmodule power block is tested separately and feeds back the energy stored in the battery.

The energy to be fed back upstream through the rectifier will correspond to the difference between the discharged power and the load consumption.

Example of a battery discharge test.

The test is performed on the 4th Xmodule power block at 200 kW constant power.

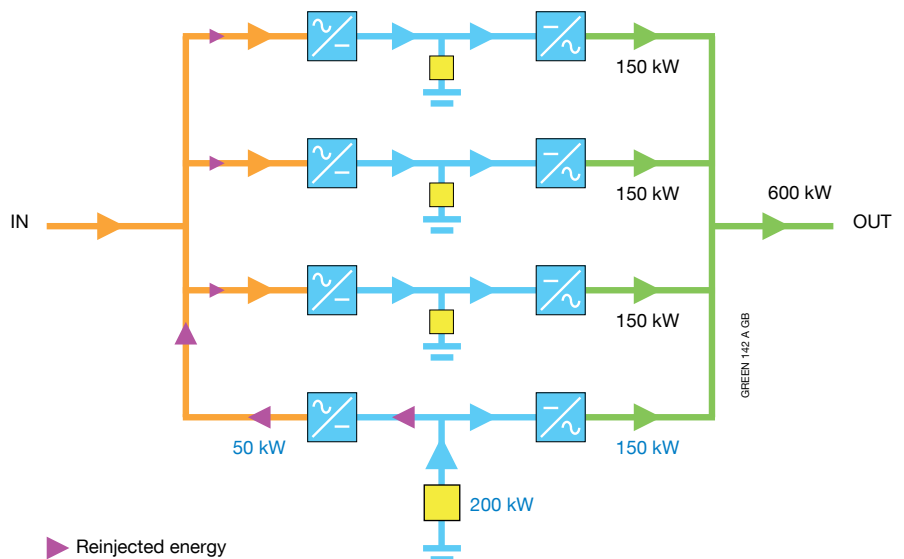

GREEN 142 A GB

Energy efficiency & adaptability

In addition of its high online efficiency, DELPHYS Xtend GP can reduce heat losses while operating under different site conditions.

Online Energy Saver mode

Energy Saver mode optimises the performance of a system working in double conversion during low load conditions:

- optimises the number of active Xmodule power blocks by switching those not being used to standby mode,
- reduction of the global system losses.

Battery on standby units remains always under charge to ensure its maximum availability.

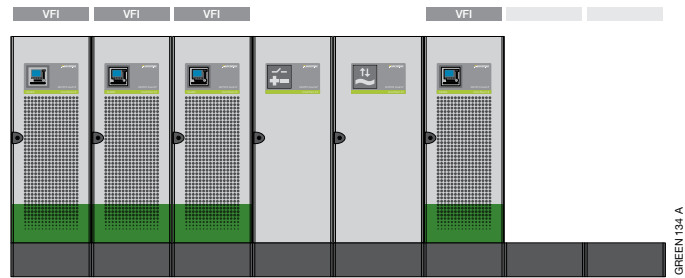
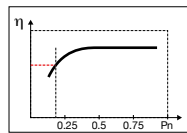

Low load condition - *Without ENERGY SAVER mode.*

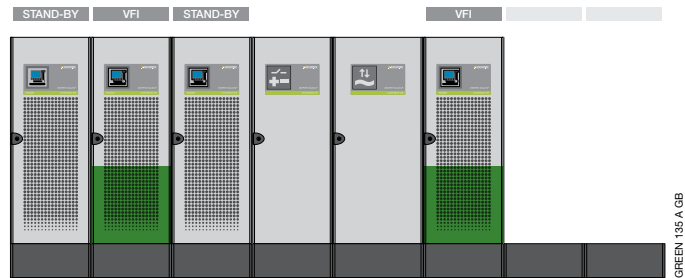
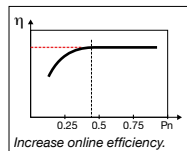

Low load condition - *With ENERGY SAVER mode.*

Fast EcoMode

DELPHYS Xtend GP can protect the critical load in online double conversion mode at full power.

Therefore, if required the system can also operate in Fast EcoMode where the system selects the bypass line when its quality is within the defined tolerances and stability.

- Increases the system's efficiency up to 99 %.
- Fast transfers from VFD to VFI mode and vice versa.

To ensure maximum availability, all batteries remain constantly under charge.

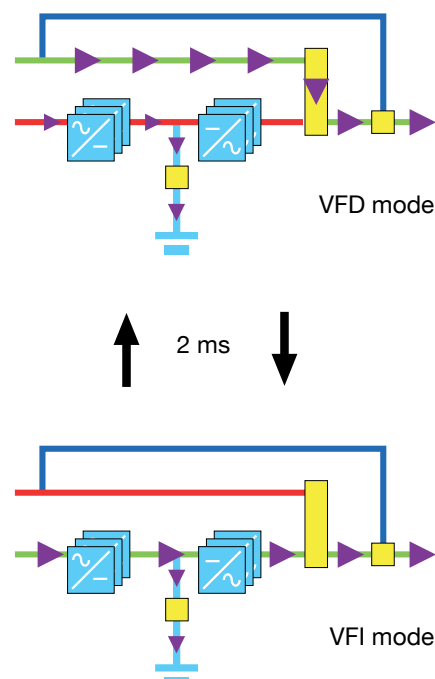

A complete solution

DELPHYS Xtend GP simplifies the connection to the upstream and downstream switchboards. It eliminates installation rework costs when new capacity is required from the IT loads. Power upgrading is performed without interrupting the energy supplied to the load thanks to pre-wired platform bays that allow the power modules to be plugged or unplugged in full safety without any modification to the site's electrical infrastructure.

Traditional parallel UPS scalable design

- The switchboard has to be designed for future UPS coupling capability.
- Additional cost and time needed for connecting the additional unit(s) to the upstream and downstream panels (in the raised floor, cables trays...).

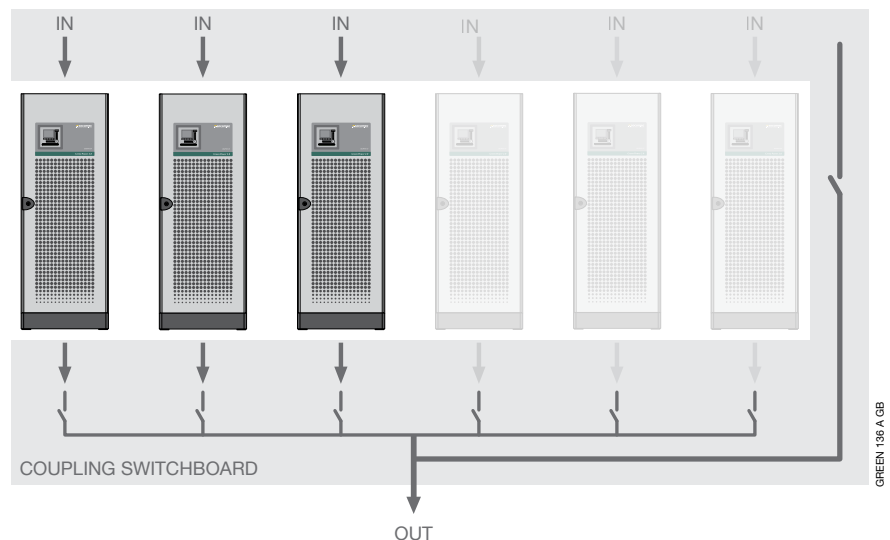

DELPHYS Xtend GP solution

- Simplifies the In / Out switchboard. The system integrates localised coupling capability.
- Fast and cost-effective scalability as there is no need to connect the additional Xmodule power block(s) to any upstream or downstream panel.
- Keeps the critical applications protected in online double conversion mode during power extension.

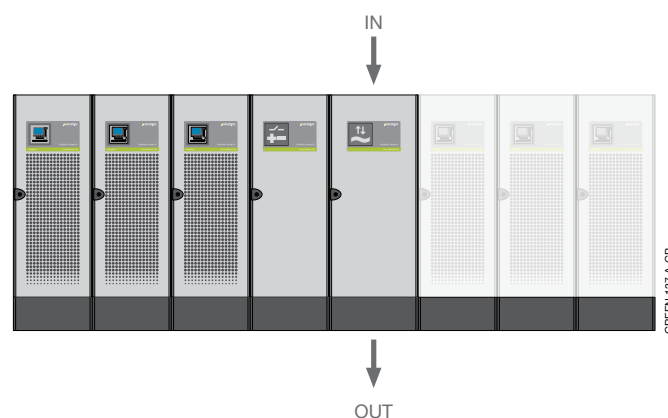

Total system flexibility

DELPHYS Xtend GP is built on a flexible brick concept. It is fully adaptable to all types of infrastructure and environments.

The hot scalability feature means you can scale your system according to your initial power requirements, at the same time keeping your power options open depending on future evolutions.



Adaptable disposition

The system disposition and physical connection is easily adapted to your plant:

- many disposition possibilities (Linear, “U”shaped, “L-shaped”),
- the number of Xbay docks can be 6 or fewer depending on the rated power of the infrastructure,
- general input/output AC connections available for top or bottom entry,
- back-up storage DC connection available for top or bottom entry.

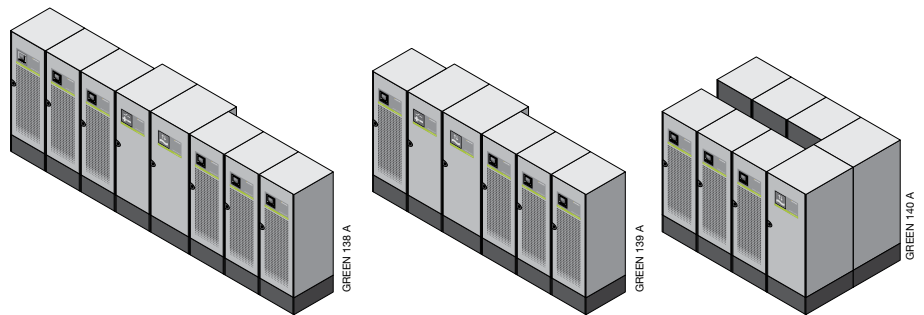

Example of configurations (left to right): linear with 6 Xmodule power blocks, linear with 4 Xmodule power blocks, “U-shape” with 6 Xmodule power blocks.



Flexible UPS architecture

An adapted solution that can meet all of your requirements in terms of power availability and scalability.

- Scalable power and energy storage capability.
- **Distributed or centralised** static bypass.
- **Common or separated** rectifier and bypass mains.
- Can be connected to **shared or distributed batteries** for energy storage optimisation.
- Compatible with different energy storage technologies.



Get more out of your product with a manufacturer's dedicated services

We have developed a full set of innovative services around DELPHYS XTEND GP in order to enhance the performance and service life of your product.

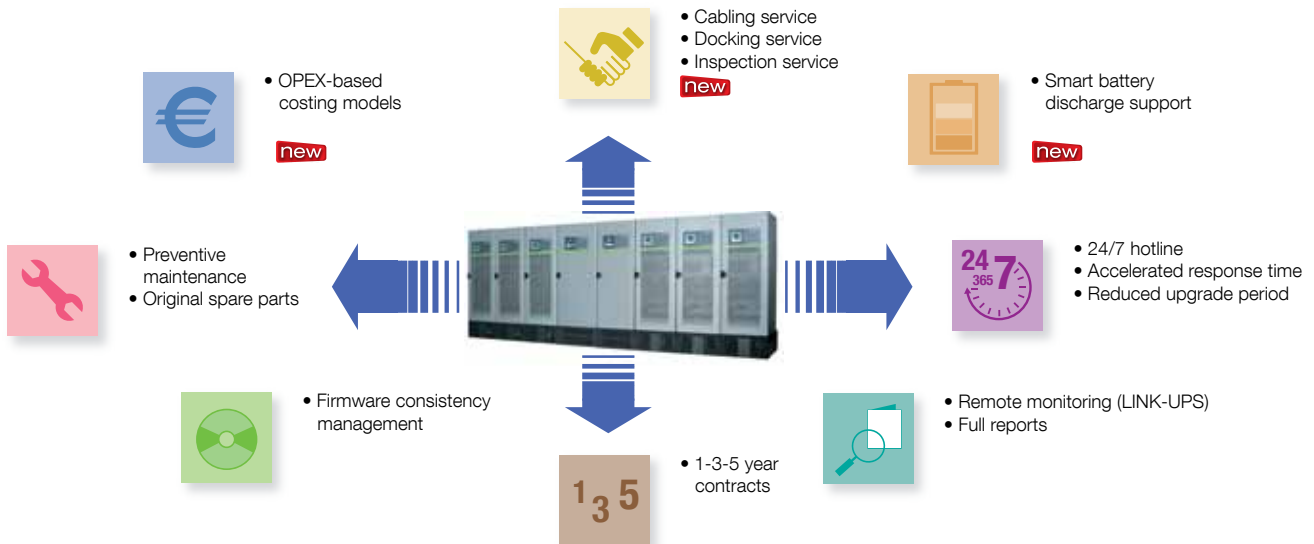

These innovative services aim at optimising your investment all along the product lifecycle while ensuring optimum availability and performance of your critical applications.



Easier scalability

- Optimised upgrading.
- Full maintenance of the system for its entire service life.
- Guaranteed firmware consistency.



Higher availability

- 24/7 hotline.
- Fast response time to site.
- On site and remote maintenance.
- Battery discharge support from study to implementation.



Better cost management

- OPEX-based pricing options.
- One single contract.
- Several duration periods.

Benefit from a manufacturer's expertise

Expert service engineers

- 370 Socomec service engineers in 20+ subsidiaries.
- 175 Business Partner service engineers in 70+ countries.
- 3,500 hours of technical training provided per year (product, methodology and safety).

Technical hotline network

- 20+ languages spoken by Socomec's technical hotline staff.
- 3 advanced technical support centres.
- 90,000+ incoming calls handled per year.

Services

- Specialist team of engineers on-call 24/7.
- Technical expertise on-site in under 6 hours guaranteed.
- Power quality and thermal imaging audit.
- On-site tests, commissioning and training.
- Certified preventive maintenance visit.
- Remote monitoring and proactive diagnostic.
- Corrective maintenance with original spare parts.
- 24/7 original spare part stock availability.
- High priority spare part shipment.



Technical specifications



Proven technology

- Green Power 2.0 range.
- Many years of field-proven technology.
- No risk of downtime in any situation.
- Load protected by true online double conversion during power upgrading or maintenance.
- Accurate check-up can be done via dedicated servicing access on all the modules.
- Risk-free and concurrent maintenance.



High resilience

- No risk of failure propagation thanks to selective Xmodule disconnection with galvanic separation.
- Parallel distributed management and load sharing without centralised control.
- Redundant parallel bus connection (ring configuration).
- Electronic watchdog to ensure emergency bypass in case of critical fault event.
- Fault-tolerant design.
- Configurable N+1 redundancy.

DELPHYS Xtend GP													
SYSTEM CONFIGURATION													
Xmodule rated power	200 kVA/kW												
Number of Xbay docks	4			5				6					
Number of Xmodule power blocks (200 kVA/kW)	2	3	4	2	3	4	5	2	3	4	5	6	
Power (kVA/kW)	N configuration	400	600	800	400	600	800	1000	400	600	800	1000	1200
	N+1 redundant configuration	200	400	600	200	400	600	800	200	400	600	800	1000
RECTIFIER INPUT ⁽¹⁾													
Voltage	400 V 3ph (200 to 480 V ⁽²⁾)												
Frequency	50 / 60 Hz												
Power factor	> 0.99												
Total harmonic distortion (THDI) at full load and rated voltage	2.5% ⁽³⁾												
INVERTER													
Rated output voltage	400 V 3ph + N (380 / 415 V configurable)												
Rated output frequency	50 / 60 Hz (selectable)												
Harmonic voltage distortion	ThdU ≤ 1.5% with rated linear load												
BYPASS													
Rated voltage	nominal output voltage ±15% (settable)												
Rated frequency	50 / 60 Hz (selectable)												
XMODULE EFFICIENCY													
Online double conversion mode	up to 96%												
Fast EcoMode	up to 99%												

(1) IGBT rectifier. (2) Conditions apply. (3) With input THDV < 1%.

Dimensions

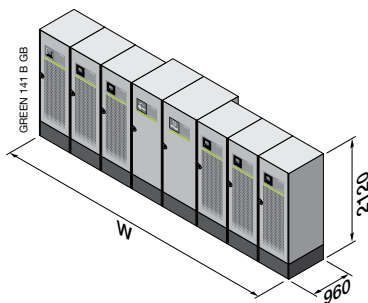

LINEAR INTEGRATION ⁽¹⁾		NUMBER OF XBAY DOCKS	W (mm)
Distributed Bypass	Common or separated inputs	4	4340
		5	5050
		6	5760
Centralised Bypass	Common input mains	4	4840
		5	5550
		6	6260
	Separated input mains	4	5340
		5	6050
		6	6760

(1) Please consult us for any other configuration.

Socomec worldwide

IN EUROPE

BELGIUM

Critical Power / Power Control & Safety /
Energy Efficiency / Solar Power

Tel. +32 2 340 02 30
Fax +32 2 346 28 99
info.be@socomec.com

FRANCE

Critical Power / Power Control & Safety /
Energy Efficiency / Solar Power

Tel. +33 1 45 14 63 00
Fax +33 1 48 67 31 12
dcm.ups.fr@socomec.com

GERMANY

Critical Power

Tel. +49 621 71 68 40
Fax +49 621 71 68 444
info.ups.de@socomec.com

Power Control & Safety / Energy Efficiency

Tel. +49 7243 65292 0
Fax +49 7243 65292 13
info.scp.de@socomec.com

ITALY

Critical Power

Tel. +39 02 98 242 942
Fax +39 02 98 240 723
info.ups.it@socomec.com

Power Control & Safety / Energy Efficiency

Tel. +39 02 98 49 821
Fax +39 02 98 24 33 10
info.scp.it@socomec.com

Solar Power

Tel. +39 0444 598611
Fax +39 0444 598627
info.solar.it@socomec.com

NETHERLANDS

Critical Power / Power Control & Safety /
Energy Efficiency / Solar Power

Tel. +31 30 760 0900
Fax +31 30 637 2166
info.nl@socomec.com

POLAND

Critical Power / Solar Power

Tel. +48 22 825 73 60
Fax. +48 22 825 73 70
info.ups.pl@socomec.com

Power Control & Safety / Energy Efficiency

Tel. +48 91 442 64 11
Fax +48 91 442 64 19
info.scp.pl@socomec.com

PORTUGAL

Critical Power / Power Control & Safety /
Energy Efficiency / Solar Power

Tel. +351 261 812 599
Fax +351 261 812 570
info.ups.pt@socomec.com

ROMANIA

Critical Power / Power Control & Safety /
Energy Efficiency / Solar Power

Tel. +40 21 319 36 88
Fax +40 21 319 36 89
info.ro@socomec.com

RUSSIA

Critical Power / Power Control & Safety /
Energy Efficiency / Solar Power

Tel. +7 495 775 19 85
Fax +7 495 775 19 85
info.ru@socomec.com

SLOVENIA

Critical Power / Power Control & Safety /
Energy Efficiency / Solar Power

Tel. +386 1 5807 860
Fax +386 1 561 11 73
info.si@socomec.com

SPAIN

Critical Power / Power Control & Safety /
Energy Efficiency / Solar Power

Tel. +34 93 540 75 75
Fax +34 93 540 75 76
info.es@socomec.com

TURKEY

Critical Power / Power Control & Safety /
Energy Efficiency / Solar Power

Tel. +90 216 540 71 20-21-22
Fax +90 216 540 71 27
info.tr@socomec.com

UNITED KINGDOM

Critical Power

Tel. +44 1285 863 300
Fax +44 1285 862 304
info.ups.uk@socomec.com

Power Control & Safety / Energy Efficiency

Tel. +44 1462 440 033
Fax +44 1462 431 143
info.scp.uk@socomec.com

IN ASIA PACIFIC

AUSTRALIA

Critical Power / Power Control & Safety

Tel. +61 2 9325 3900
Fax +61 2 9888 9544
info.ups.au@socomec.com

CHINA

Critical Power / Power Control & Safety /
Energy Efficiency

Tel. +86 21 52 98 95 55
Fax +86 21 62 28 34 68
info.cn@socomec.com

INDIA

Critical Power / Power Control & Safety /
Energy Efficiency / Solar Power

Tel. +91 44 39215400
Fax +91 44 39215450 & 51
info.in@socomec.com

SINGAPORE

Critical Power / Power Control & Safety /
Energy Efficiency

Tel. +65 6506 7600
Fax +65 64 58 7377
info.sg@socomec.com

THAILAND

Critical Power

Tel. +66 2 941 1644 7
Fax +66 2 941 1650
info.ups.th@socomec.com

IN MIDDLE EAST

UNITED ARAB EMIRATES

Critical Power / Power Control & Safety /
Energy Efficiency / Solar Power

Tel. +971 4 29 98 441
Fax +971 4 29 98 449
info.ae@socomec.com

IN AMERICA

USA, CANADA & MEXICO

Power Control & Safety / Energy Efficiency

Tel. +1 617 245 0447
Fax +1 617 245 0437
info.us@socomec.com

OTHER COUNTRIES

NORTH AFRICA

Algeria / Morocco / Tunisia
info.naf@socomec.com

AFRICA

Other countries
info.africa@socomec.com

SOUTH EUROPE

Cyprus / Greece / Israel / Malta
info.se@socomec.com

SOUTH AMERICA

Tel. +34 93 540 75 75
info.es@socomec.com

MORE DETAILS

www.socomec.com/worldwide

HEAD OFFICE

SOCOMECS GROUP

SAS SOCOMECS capital 10738740 €
R.C.S. Strasbourg B 548 500 149
B.P. 60010 - 1, rue de Westhouse
F-67235 Benfeld Cedex - FRANCE
Tel. +33 3 88 57 41 41
Fax +33 3 88 74 08 00
info.scp.isd@socomec.com

www.socomec.com

YOUR DISTRIBUTOR

